

Az ábrán egy síklapokkal határolt test rendezett felül-, oldal- és előnézeti képeit láthatjuk. Mi lehet a test? Rajzoljuk meg egy általános (pl. axonometrikus) vetületét!

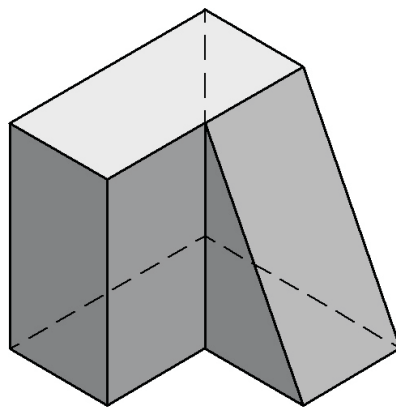

*Megoldás*

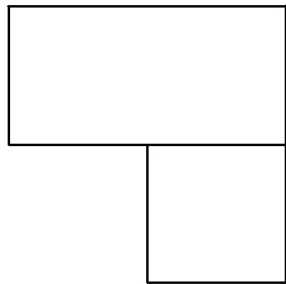
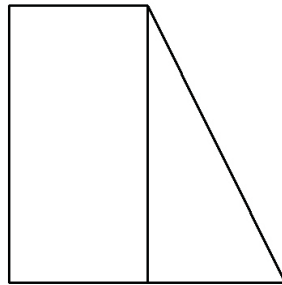
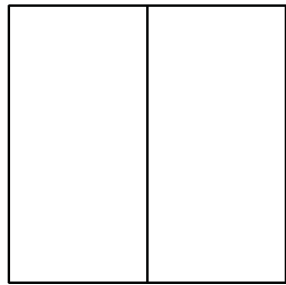
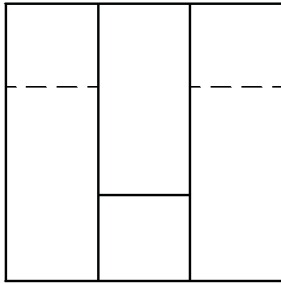
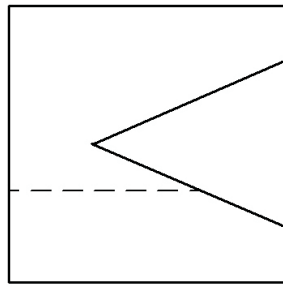
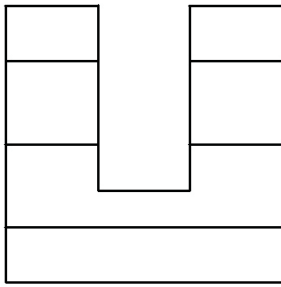

Az ábrán egy síklapokkal határolt test rendezett felül-, oldal- és előnézeti képeit láthatjuk. Mi lehet a test? Rajzoljuk meg egy általános (pl. axonometrikus) vetületét!

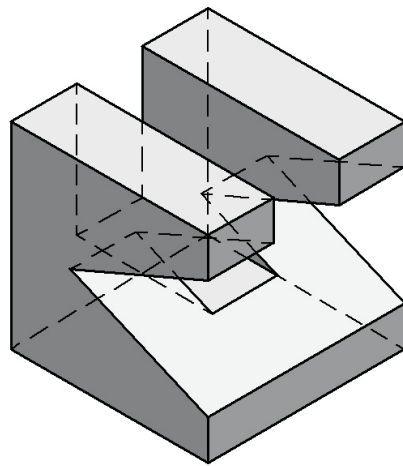
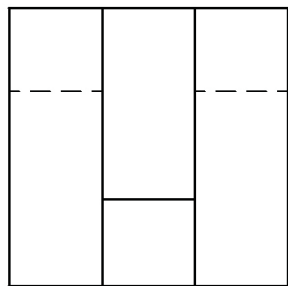
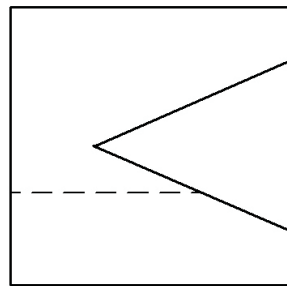
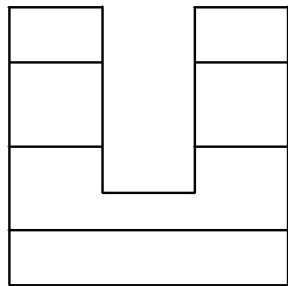

*Megoldás*

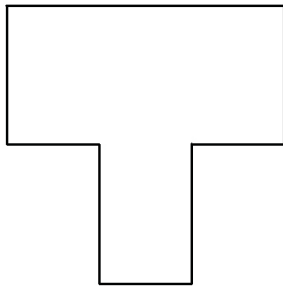
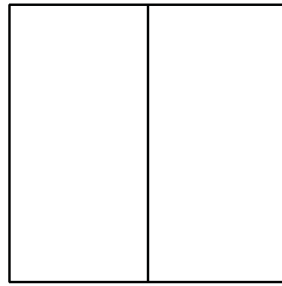
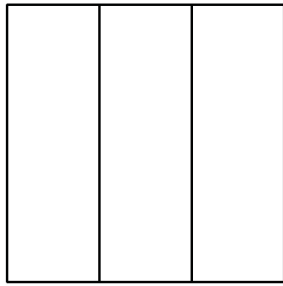

Az ábrán egy síklapokkal határolt test rendezett felül-, oldal- és előlnézeti képeit láthatjuk. Mi lehet a test? Rajzoljuk meg egy általános (pl. axonometrikus) vetületét!

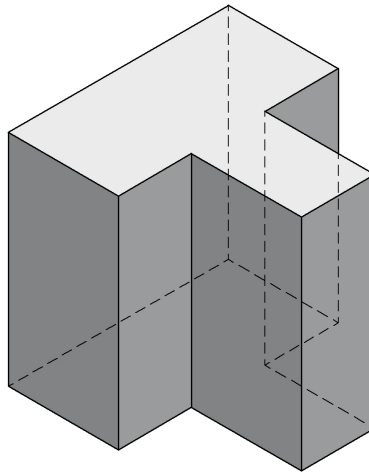
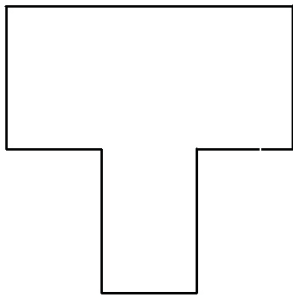
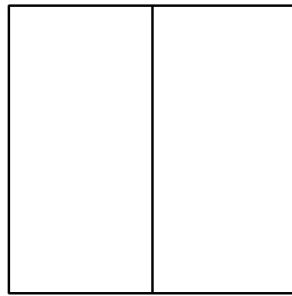
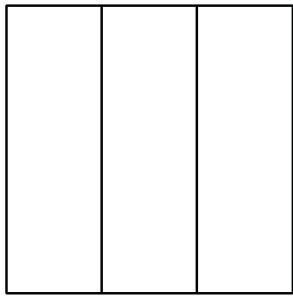

*Megoldás*

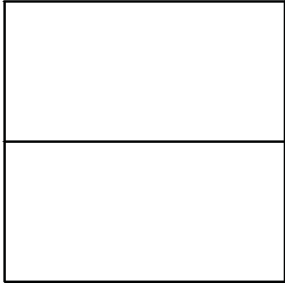
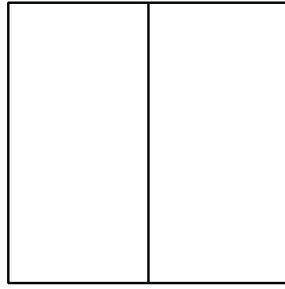
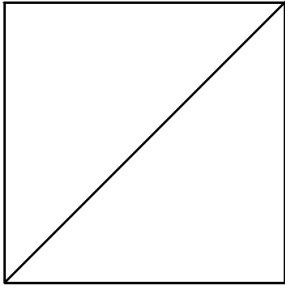

Az ábrán egy síklapokkal határolt test rendezett felül-, oldal- és előlnézeti képeit láthatjuk. Mi lehet a test? Rajzoljuk meg egy általános (pl. axonometrikus) vetületét!

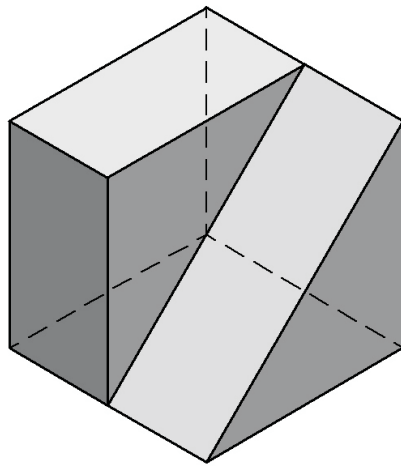
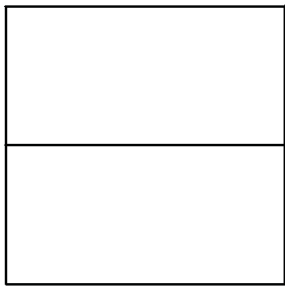
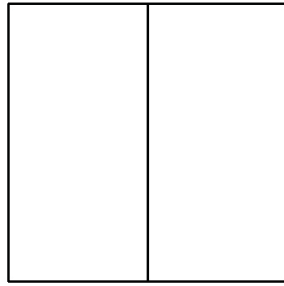
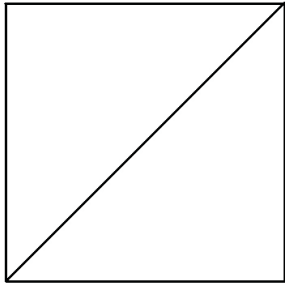

*Megoldás*



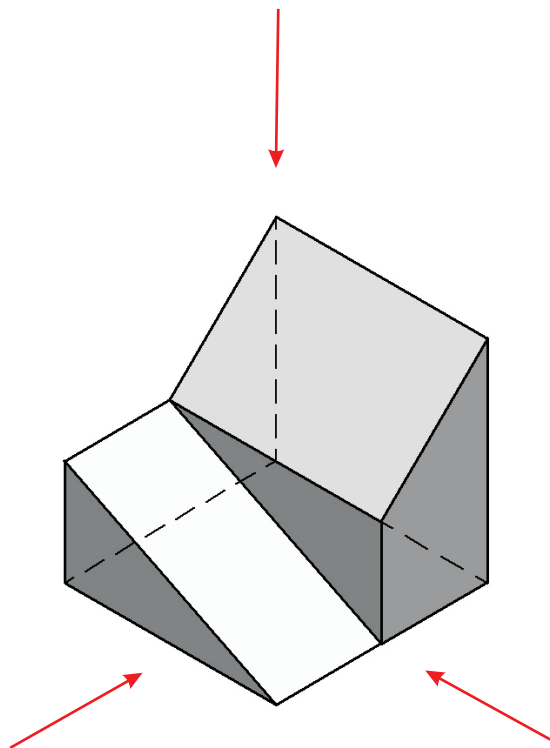

Rajzoljuk meg a fönti, síklapokkal határolt testnek a nyilakkal jelölt irányokból adódó három rendezett vetületét!

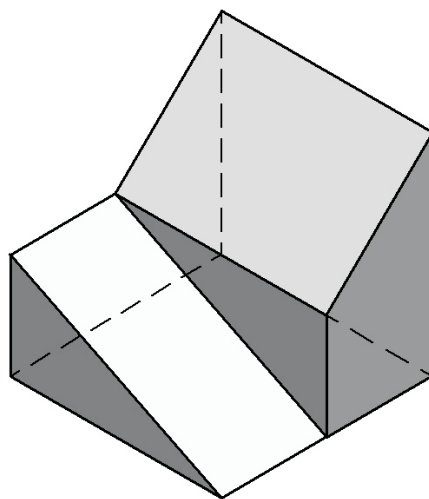
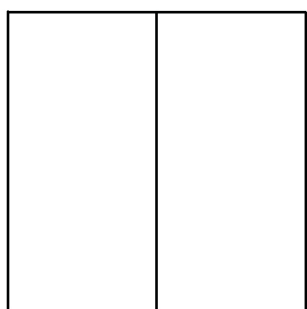
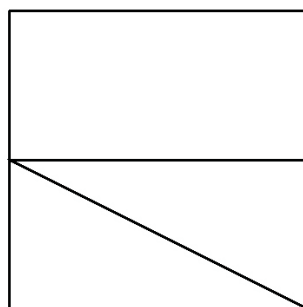
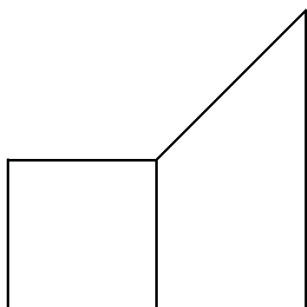

*Megoldás*

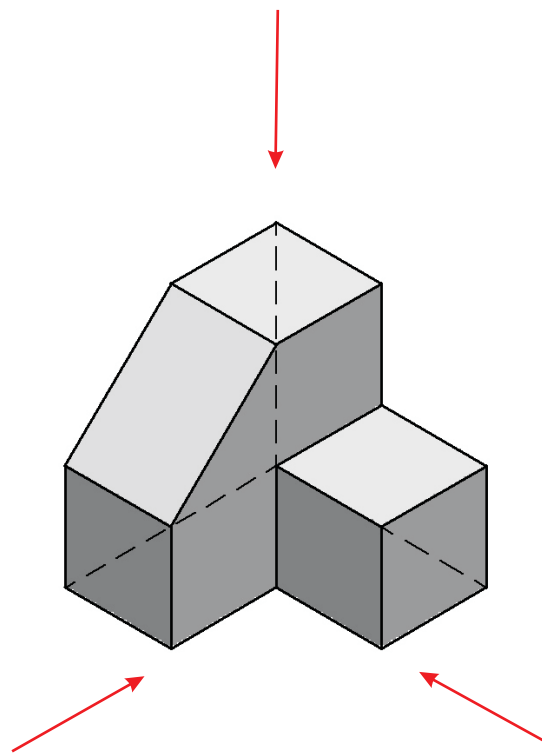

Rajzoljuk meg a fönti, síklapokkal határolt testnek a nyilakkal jelölt irányokból adódó három rendezett vetületét!

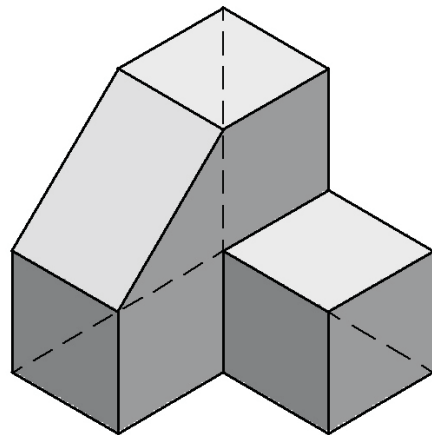
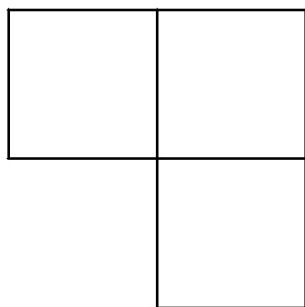
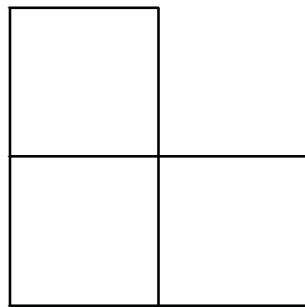
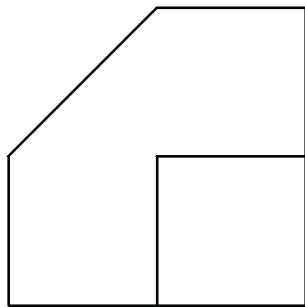

*Megoldás*

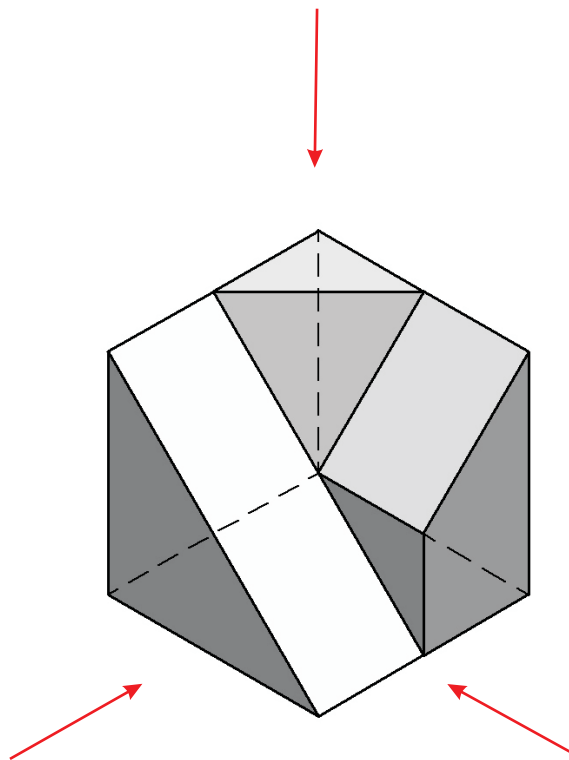

Rajzoljuk meg a fönti, síklapokkal határolt testnek a nyilakkal jelölt irányokból adódó három rendezett vetületét!

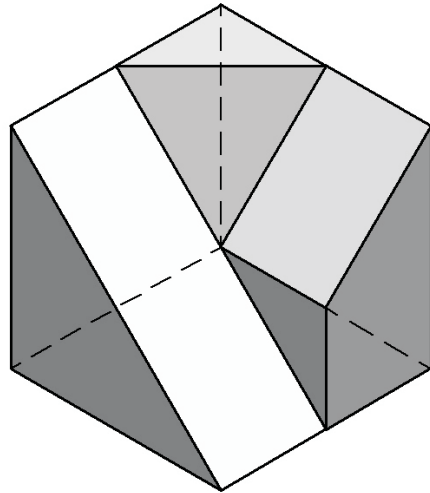
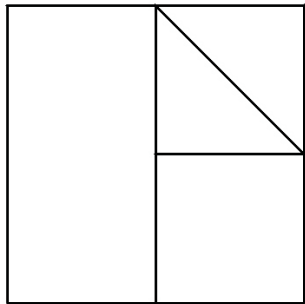
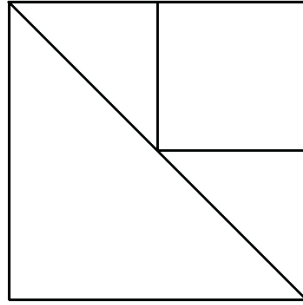
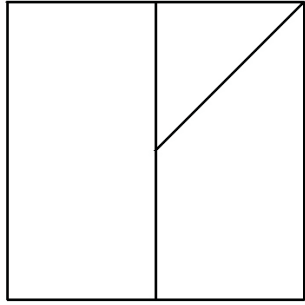

*Megoldás*